

HINGED LOCKABLE
WATERPROOF DOOR

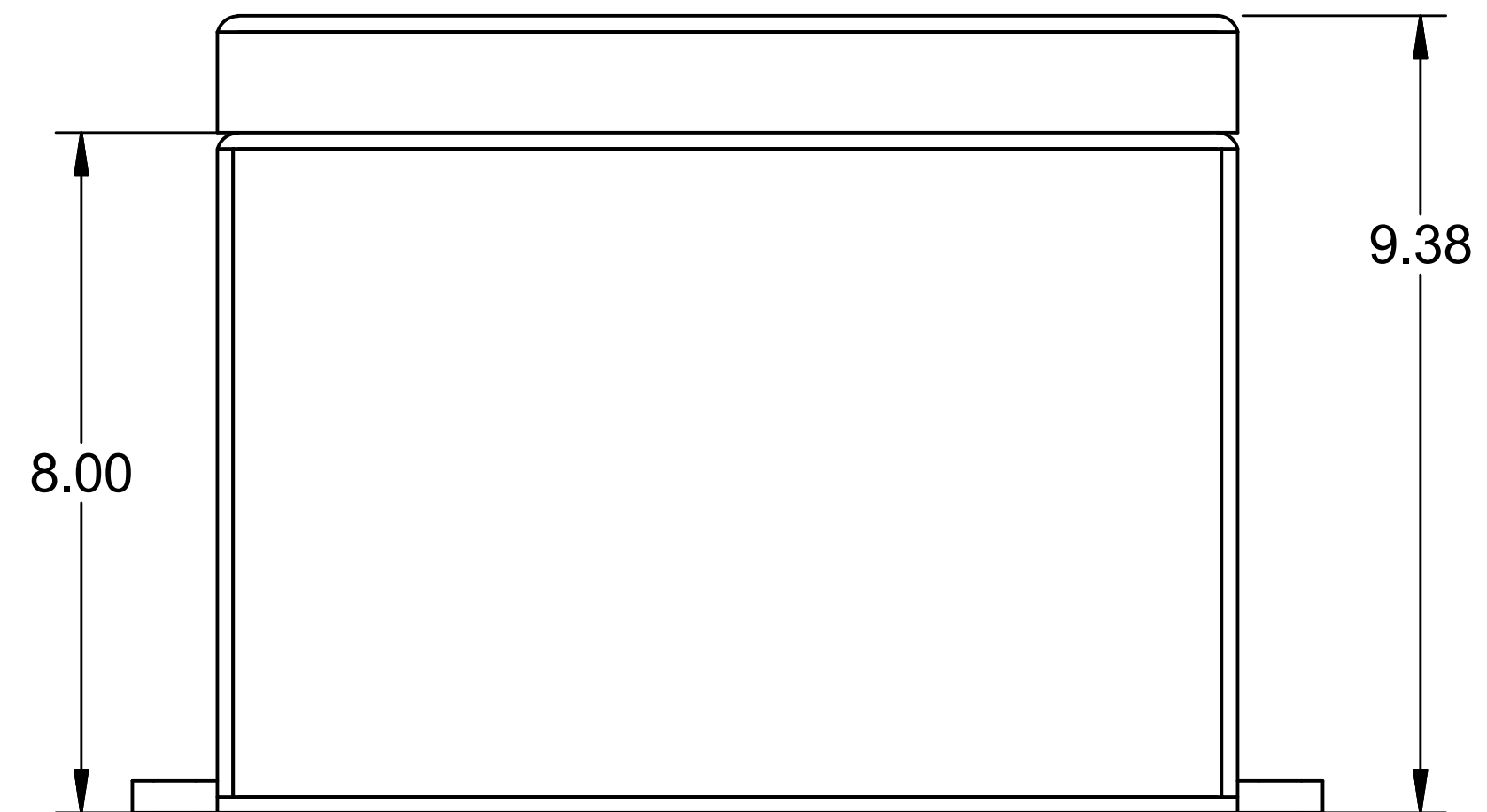
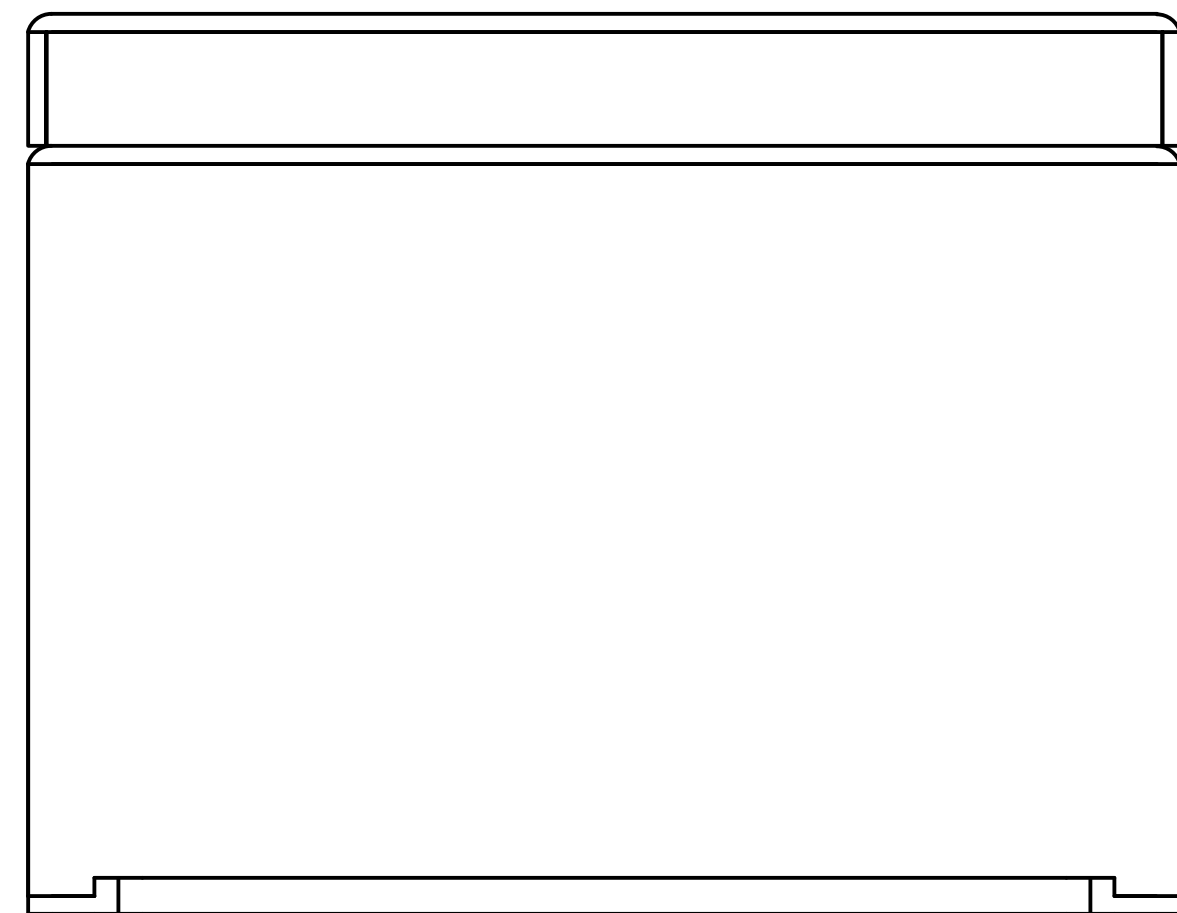
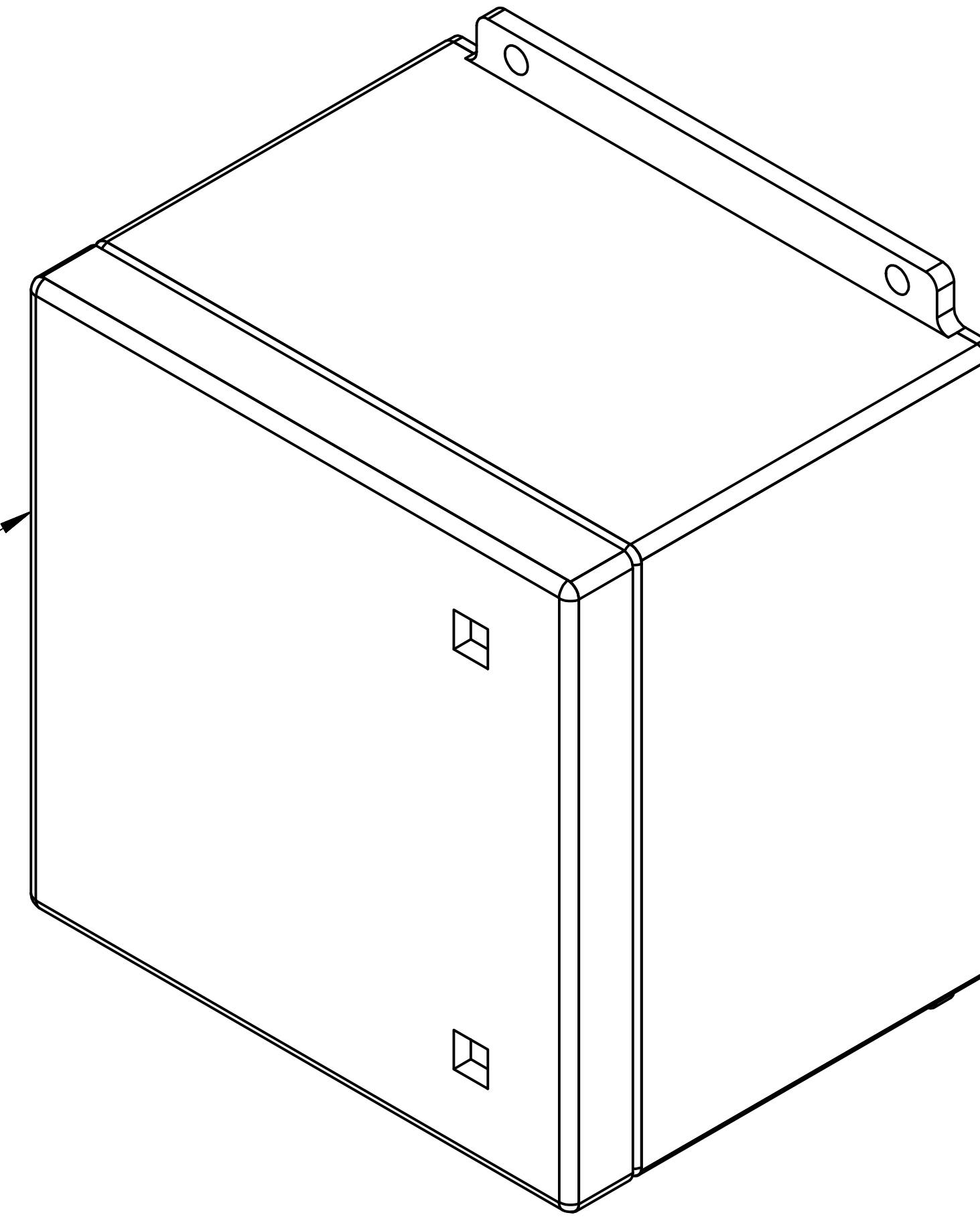

DESIGN APPROVAL
 BY SIGNING THIS FORM, YOU ARE AUTHORIZING INTERACTIVE
 DYNAMICS TO PROCEED WITH MANUFACTURING.
 DATE: _____
 SIGNATURE: _____

UNLESS OTHERWISE SPECIFIED: ALL DIMENSIONS ARE IN INCHES. ALL TOLERANCES APPLY TO THE FINISHED PART, EXCLUDING PAINT		MATERIAL: ABS 3/8"		
TOLERANCES	ANGLES	DWN BY: DM		
X = ±	± 1°	CHK BY:		
.XX = ± .03	HOLES	APR BY:	TITLE:	
.XXX = ± .015	± .003"	DATE: 12/15/2015	HD UTILITY WASHDOWN ENCLOSURE	
THESE DRAWINGS ARE THE EXCLUSIVE PROPERTY OF DUST-SHIELD ISSUED IN STRICT CONFIDENCE AND SHALL NOT BE REPRODUCED, COPIED OR USED FOR ANY PURPOSE WHATSOEVER, WITHOUT PRIOR WRITTEN PERMISSION		SCALE: NTS	SHEET 1 OF 1	DRAWING NUMBER: DS-12128B
			REV: IR	