

HINGED LOCKABLE
WATERPROOF DOOR

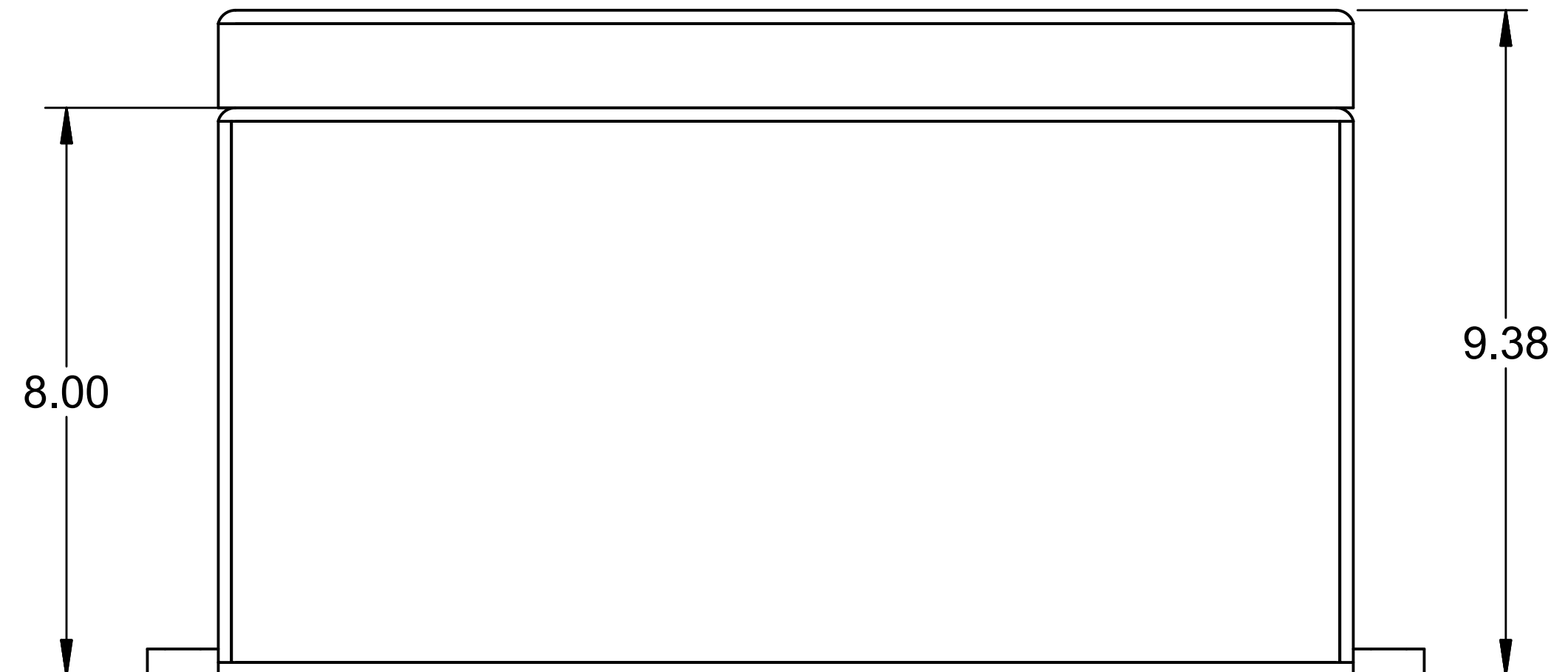
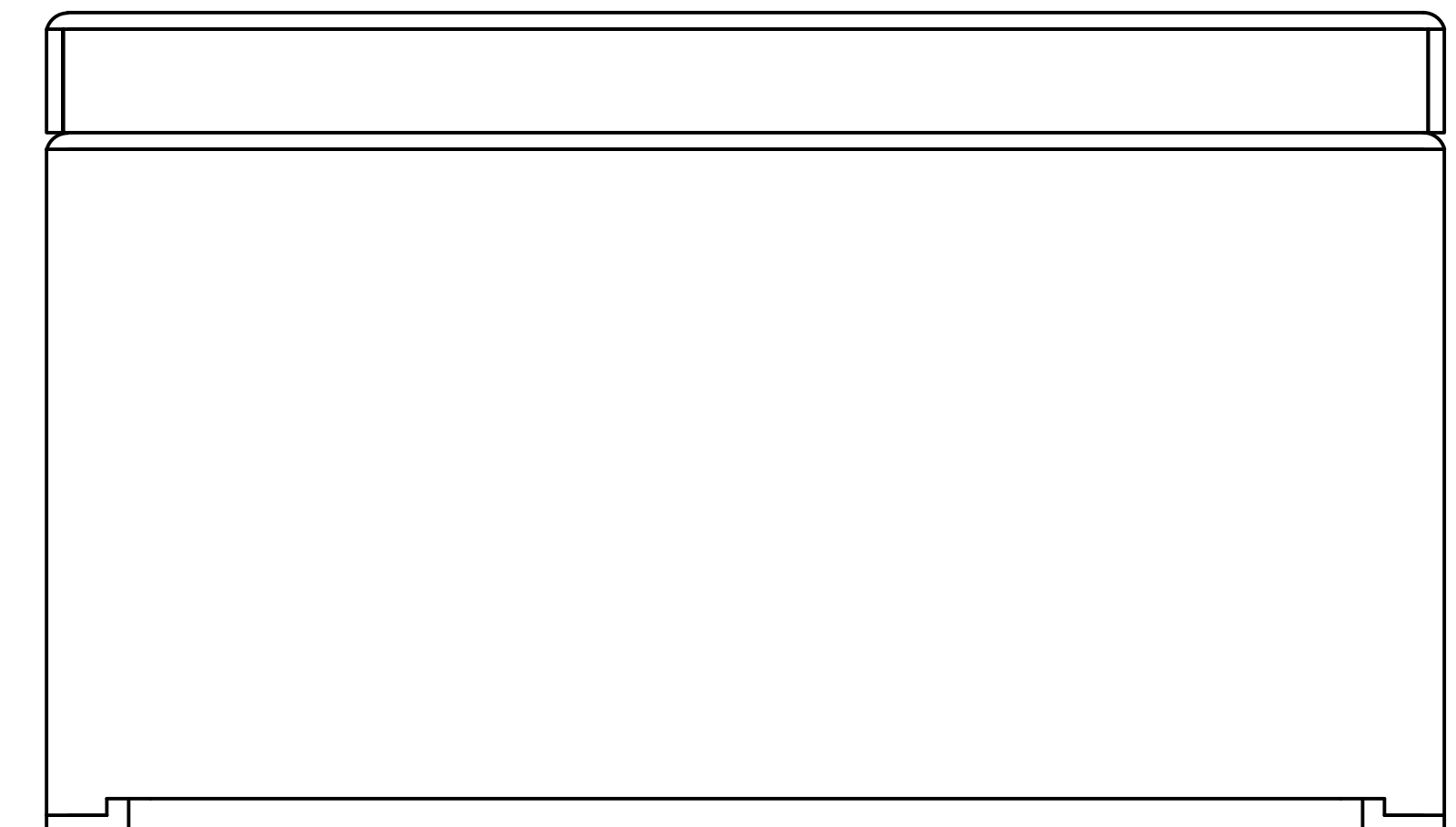
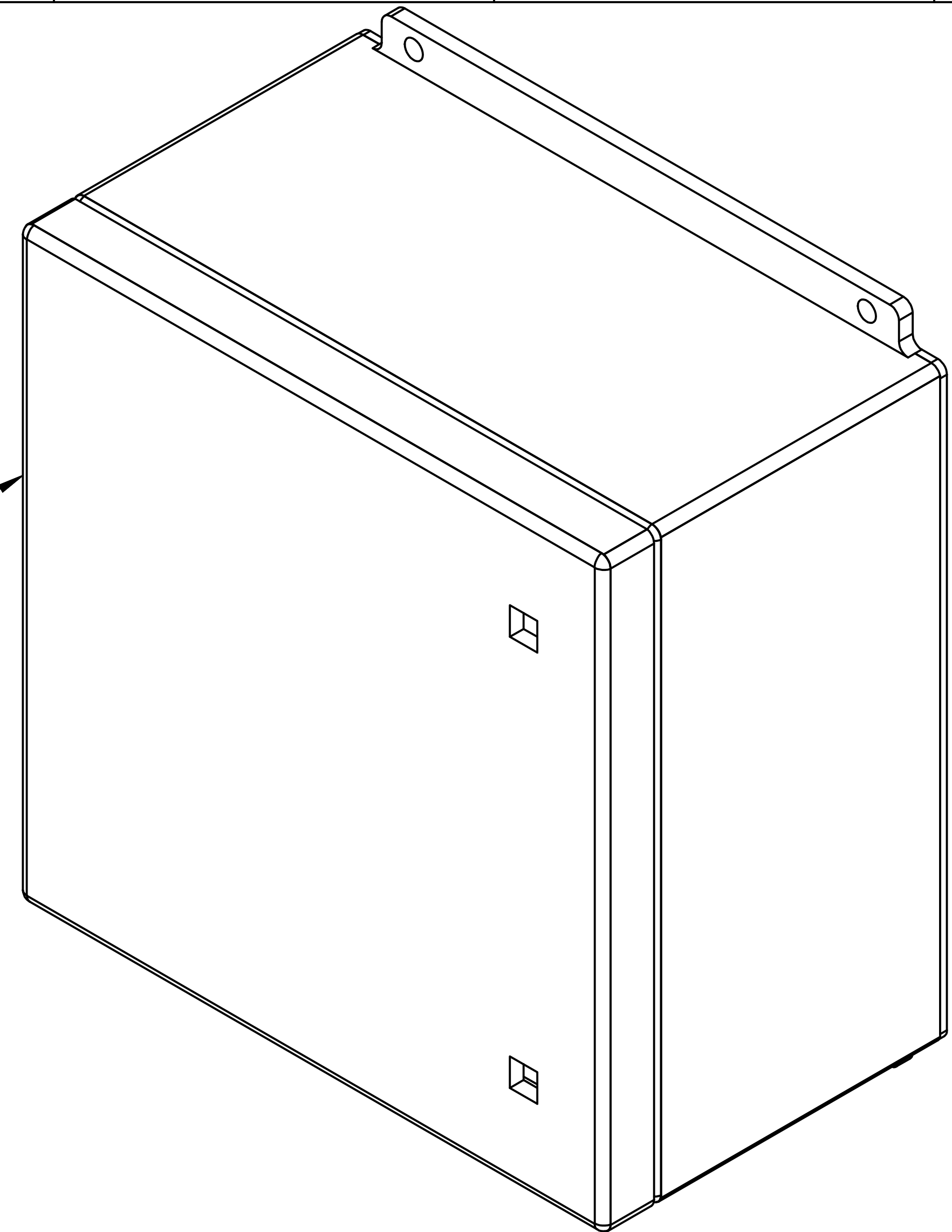

DESIGN APPROVAL
 BY SIGNING THIS FORM, YOU ARE AUTHORIZING INTERACTIVE DYNAMICS TO PROCEED WITH MANUFACTURING.
 DATE: _____
 SIGNATURE: _____

UNLESS OTHERWISE SPECIFIED: ALL DIMENSIONS ARE IN INCHES. ALL TOLERANCES APPLY TO THE FINISHED PART, EXCLUDING PAINT		MATERIAL: ABS 3/8"		
TOLERANCES	ANGLES	DWN BY: DM		
X = ±	± 1°	CHK BY:		
.XX = ± .03	HOLES	APR BY:	TITLE: HD UTILITY WASHDOWN ENCLOSURE	
.XXX = ± .015	± .003"	DATE: 12/15/2015	DRAWING NUMBER: DS-16168B	
THESE DRAWINGS ARE THE EXCLUSIVE PROPERTY OF DUST SHIELD. ISSUED IN STRICT CONFIDENCE AND SHALL NOT BE REPRODUCED, COPIED OR USED FOR ANY PURPOSE WHATSOEVER, WITHOUT PRIOR WRITTEN PERMISSION.		SCALE: NTS	SHEET 1 OF 1	REV: IR